

DESIGN AND ANALYSIS OF CONTROLLERS FOR STATCOM APPLICATIONS IN FREQUENCY RESPONSE METHOD FOR REACTIVE POWER COMPENSATION IN LINEAR LOADS

J.K. Moharana

Department of Electrical Engineering, HIT, BBSR, Odisha, India

ABSTRACT

The STATCOM (STATIC synchronous COMPensator) is a shunt connected voltage source converter using self-commutating device and can be effectively used for reactive power control. Its principle of operation is similar to that of a synchronous condenser. This paper describes the modeling of STATCOM along with design of current controller and voltage controller. The design of controllers for the converters can be realized in frequency response method. The transfer function of the STATCOM is a first order system and hence root locus and bode plot are plotted to get the parameters of the PI controller. The frequency response approach is adopted and simulated waveforms are presented.

Key words: Controller design, PI Controller, STATCOM.

Cite this Article: J.K. Moharana, Design and Analysis of Controllers for STATCOM Applications in Frequency Response Method for Reactive Power Compensation in Linear Loads. *International Journal of Electrical Engineering & Technology*, 9(3), 2018, pp. 89–99.

<http://www.iaeme.com/IJEET/issues.asp?JType=IJEET&VType=9&IType=3>

1. INTRODUCTION

Power Electronics Devices are gaining popularity for applications in the field of power transmission and distribution systems. Reactive power (VAR) compensation and control have been recognized [1] as an efficient & economic means of increasing power system transmission capability and voltage stability. The FACTS (Flexible AC Transmission Systems) devices, such as STATCOM have been introduced more recently[2-4]. The controllable reactive power allows for a rapid control of bus voltage and power factor at the system or at the load end. To compensate for the distorted current drawn by the rectifiers from the utility grid, the STATCOM and its current controller must have the capability to track source PWM (Pulse Width Modulation) converters. The linear control is more suitable for STATCOM application reported in [5-8]. The paper suggests the design of a linear current

controller and voltage controller on the basis of gain and time constant adjustment along with the parameter of the coupling inductor and storage capacitor.

The organization of this paper is as follows. The paper initially focuses on the modeling of the STATCOM with the system. Then after current controller and voltage controller are designed with parametric and frequency based. Finally the simulated results are presented with discussion.

2. MODELING OF STATCOM

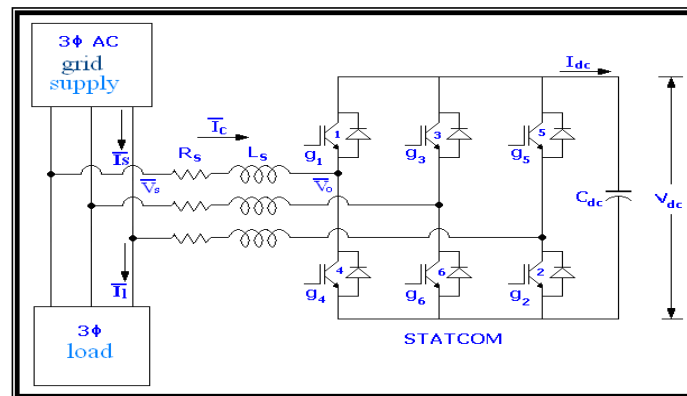

Figure 1 Configuration of STATCOM

The system voltages, V_{sa} , V_{sb} and V_{sc} are assumed to be sinusoidal and balanced, can be expressed as

$$\begin{bmatrix} V_{sa} \\ V_{sb} \\ V_{sc} \end{bmatrix} = \sqrt{\frac{2}{3}} V_s \begin{bmatrix} \sin(\omega t) \\ \sin(\omega t - \frac{2\pi}{3}) \\ \sin(\omega t + \frac{2\pi}{3}) \end{bmatrix} \quad (1)$$

According to Fig.1, the system currents flowing to STATCOM are shown in (2). The d-q transformation of the ingoing currents and their state space model [5] are shown in (3-4) and (5) respectively.

$$L_s \frac{d}{dt} (i_{abc}) = -R_s i_{abc} + V_{sabc} - V_{0abc} \quad (2)$$

$$L_s \frac{d}{dt} (i_q) = -R_s i_q - \omega L_s i_d + V_{sq} - V_{0q} \quad (3)$$

$$L_s \frac{d}{dt} (i_d) = -R_s i_d + \omega L_s i_q + V_{sd} - V_{0d} \quad (4)$$

$$\frac{d}{dt} \begin{bmatrix} i_q \\ i_d \end{bmatrix} = \begin{bmatrix} -\frac{R_s}{L_s} & -\omega \\ \omega & -\frac{R_s}{L_s} \end{bmatrix} \begin{bmatrix} i_q \\ i_d \end{bmatrix} + \frac{1}{L_s} \begin{bmatrix} V_{sq} \\ V_{sd} \end{bmatrix} - \begin{bmatrix} V_{0q} \\ V_{0d} \end{bmatrix} \quad (5)$$

The equation (5) is a MIMO (Multiple Input Multiple and Output) system and its input and output are shown in equation (6)

$$[u] = \begin{bmatrix} V_{0q} \\ V_{0d} \end{bmatrix}, [y] = \begin{bmatrix} i_q \\ i_d \end{bmatrix} \tag{6}$$

The block diagram of the a.c.side of the STATCOM in d-q transformation as per (5) is shown in Fig.2. The instantaneous voltage of the system and the STATCOM are independent, but the active and the reactive currents are coupled with each other through the reactance of the coupled inductor. So it is very essential to decouple the active and reactive current from each other and design the controller for tracking the required value.

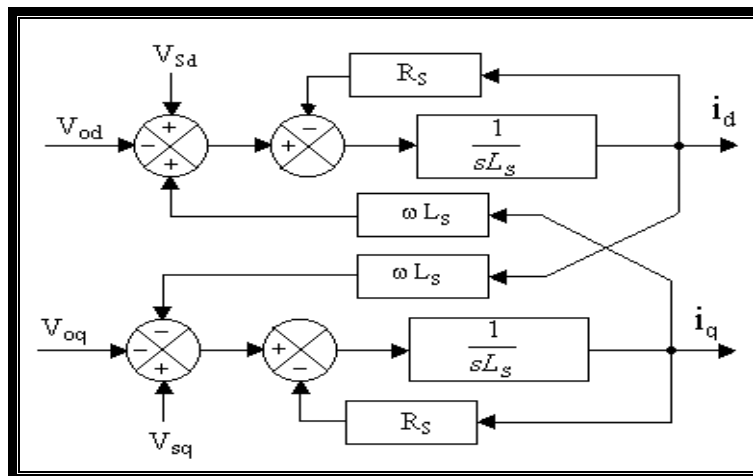

Figure 2 Equivalent Diagram on a.c. side of STATCOM

3. DESIGN OF CURRENT CONTROLLER.

The controller design for the above system can be done using the strategy [3] attempts to decouple the d and q axes equations, so that the MIMO system reduces to two independent SISO (Single Input Single Output) systems. The control inputs V_{0d} and V_{0q} are configured as

$$V_{0q} = -V_{0q}^* - \omega L_s i_q + V_{sq} \tag{7}$$

$$V_{0d} = -V_{0d}^* + \omega L_s i_d + V_{sd}$$

$$\begin{bmatrix} i_q \\ i_d \end{bmatrix} = \begin{bmatrix} -\frac{R_s}{L_s} & 0 \\ 0 & -\frac{R_s}{L_s} \end{bmatrix} \begin{bmatrix} i_q \\ i_d \end{bmatrix} + \frac{1}{L_s} \begin{bmatrix} V_{0q}^* \\ V_{0d}^* \end{bmatrix} \tag{8}$$

$$G_q(s) = \frac{I_q(s)}{V_{0q}^*(s)} = \frac{1}{R_s + sL_s}, G_d(s) = \frac{I_d(s)}{V_{0d}^*(s)} = \frac{1}{R_s + sL_s} \tag{9}$$

The equation (8) can be obtained by replacing (5) by (7). Hence each row of (8) is independent of each other and thus defines an independent SISO system. Conventional frequency-domain design methods can now be directly applied for current controller. Taking

the Laplace transformation of both sides of (8) and rearranging terms are given by (9) and their decoupled SISO system is shown in Fig.3.

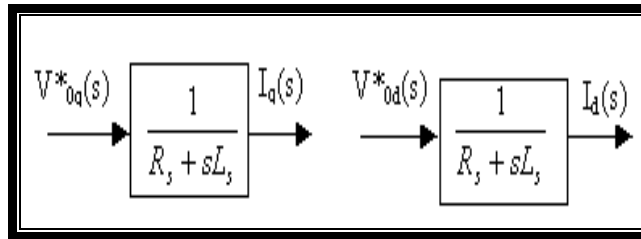

Figure 3 Current control of inverter of equivalent decoupled SISO systems

For similar dynamic behaviour of the q and d axis currents, both the q and d axis controllers are identical and its transfer function is given in (10) s

$$G_{pi}(s) = \frac{I_q(s)}{V_{0q}^*(s)} = \frac{I_d(s)}{V_{0d}^*(s)} = \frac{1}{R_s + sL_s} \quad (10)$$

The transfer function of a PI controller is

$$G_{PI}(s) = K \left(1 + \frac{1}{sT_i} \right) = K_{ip} + \frac{K_{ii}}{s} \quad (11)$$

with $K_{ip} = K$, $K_{ii} = \frac{K}{T_i}$. The transfer function in open loop of PI controller associated with the transfer function on the a.c. system is

$$\left[G_{pi}(s).G_{PI}(s) \right] = K \left[1 + \frac{1}{sT_i} \right] \left[\frac{1/R_s}{1 + sL_s/R_s} \right] \quad (12)$$

While taking $T_i = \frac{L_s}{R_s}$ and simplification which reduces to

$$\left[G_{pi}(s).G_{PI}(s) \right] = \frac{K}{sL_s} \quad (13)$$

The closed loop transfer function is

$$\left[G_{pi}(s).G_{PI}(s) \right] = \frac{1}{1 + s \frac{L_s}{K}} \quad (14)$$

Thus the system behaves like a first order with an apparent time constant as

$$\tau_a = \frac{L_s}{K} \quad (15)$$

The gain of K can be adjusted such a way that if it is increased too high then the system behaves as second order, otherwise responses very slow. The root locus of the open loop transfer function of the STATCOM with PI controller is drawn as given in Fig.4. The value of K can be determined from the locus.

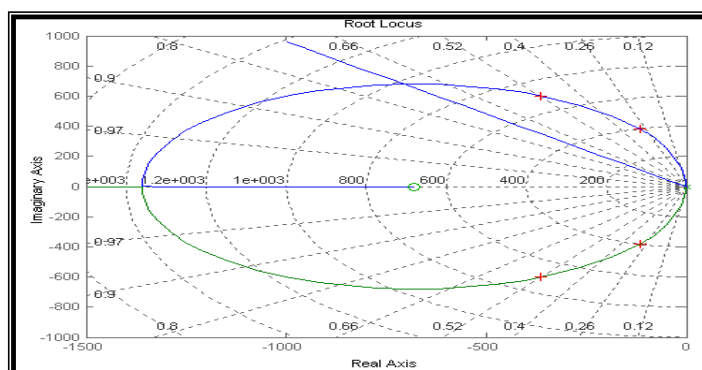

Figure 4 Root locus plot

Hence the numerical values for K_{ip} and K_{ii} are decided from the circuit parameters, L_s and R_s from the required value of K. So the parameters of PI controller are defined as

$$K_{ip} = K, K_{ii} = \frac{KR_s}{L_s} \tag{16}$$

The structure of the effective closed loop system is shown in Fig.5 and is replicated in both the q and d axis current controllers.

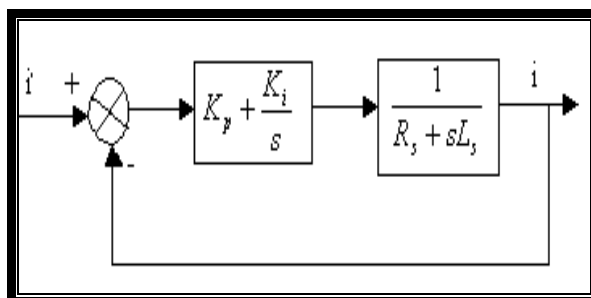

Figure 5 Effective closed loop current control system

Table 1 Values of the parameters associated to STATCOM

Meaning	Symbol	Values
Frequency	f	50 Hz
Angular frequency	w	314 rad/sec
RMS line-to-line voltage	V_s	220V
Resistance	R_s	1.0Ω
Coupling inductance	L_s	5mH
DC-link capacitor	C_{dc}	500 μF
Modulation index	m	0.866
Load resistance	R_l	23Ω
Load inductance	L_l	60mH

4. DESIGN OF VOLTAGE CONTROLLER

The switching matrix S of the inverter including the modulation index m is given by

$$S = \begin{bmatrix} S_a \\ S_b \\ S_c \end{bmatrix} = \sqrt{\frac{2}{3}} m \begin{bmatrix} \sin(\omega t + \alpha) \\ \sin(\omega t + \alpha - \frac{2\pi}{3}) \\ \sin(\omega t + \alpha + \frac{2\pi}{3}) \end{bmatrix} \quad (17)$$

In the d - q frame,

$$\begin{bmatrix} V_{0q} \\ V_{0d} \\ V_{00} \end{bmatrix} = K S V_{dc} = m \begin{bmatrix} \sin \alpha \\ \cos \alpha \\ 0 \end{bmatrix} V_{dc} \quad (18)$$

$$i_{dc} = S^T K^{-1} i_{qd0} = m(i_q \sin \alpha + i_d \cos \alpha) \quad (19)$$

$$m = \frac{\sqrt{V_{0q}^2 + V_{0d}^2}}{V_{dc}}, \alpha = \tan^{-1} \left(\frac{V_{0q}}{V_{0d}} \right) \quad (20)$$

The relation between dc voltage V_{dc} and current i_{dc} is

$$V_{dc} = \frac{1}{C} \int i_{dc} dt \quad (21)$$

Let us consider the system voltage and the output of the STATCOM voltage are to be in phase and for unit modulation index, the transfer function can be written as

$$G_{pv}(s) = \frac{V_{dc}}{i_{dc}} = \frac{1}{sC} \quad (22)$$

The transfer function in open loop of PI controller in (11) associated with the transfer function on dc side is

$$[G_{pv}(s).G_{PI}(s)]_{ol} = K \left(1 + \frac{1}{sT_i} \right) \left(\frac{1}{sC} \right) \quad (23)$$

After taking $T_i=C$ and simplifying

$$[G_{pv}(s).G_{PI}(s)]_{ol} = K \left(\frac{1 + sT_i}{s^2 T_i^2} \right) \quad (24)$$

The transfer function in closed loop

$$[G_{pv}(s).G_{PI}(s)]_{cl} = \left(\frac{1 + sT_i}{1 + sT_i + \frac{s^2 T_i^2}{K}} \right) \quad (25)$$

So the system behaves like a second order system. As

$T_i \gg \frac{T_i^2}{K}$ and magnitude plot in Fig.6 shows the initial slop at break point is approximately -20db/decade and hence it reduces to first order system.

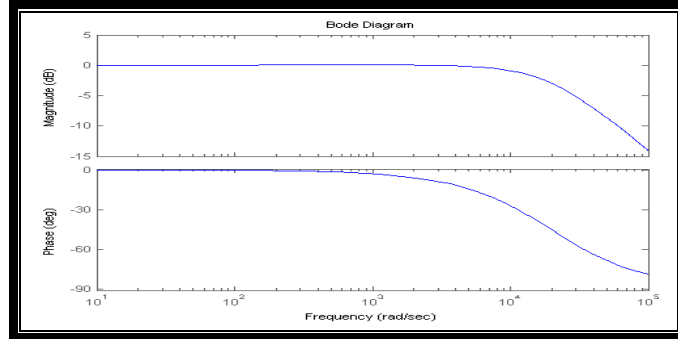

Figure 6 Bode plot of the system with PI

The value of K can be determined from root locus with approximate settling time and hence the parameters of PI controller are defined as

$$K_{vp} = K, K_{vi} = \frac{K}{C} \tag{26}$$

The system parameters are given in Table-I:

PI controller:

For current control, $K_{ip} = 1, K_{ii} = 200$

For voltage control, $K_{vp} = 0.1, K_{vi} = 200$

5. SIMULATION RESULTS

The simulated waveforms of steady and transient outputs of i_d, i_q and V_{dc} in capacitive and inductive mode are shown in Fig.7-10. As per the value of i_q obtained in steady state and transient, the authors are interested to control the reactive current as per the load. The simulations of the reference reactive current of 15A and reference DC_voltage of 500V are shown in Fig.11 and 12. These Figs show that the output current and voltage are properly follow the reference values

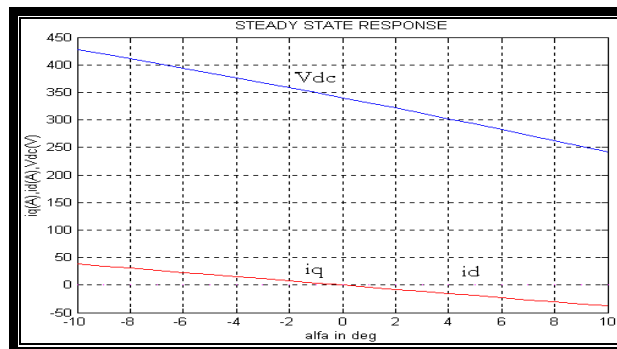

Figure 7 Steady state response of i_d and i_q

Design and Analysis of Controllers for STATCOM Applications in Frequency Response Method for Reactive Power Compensation in Linear Loads

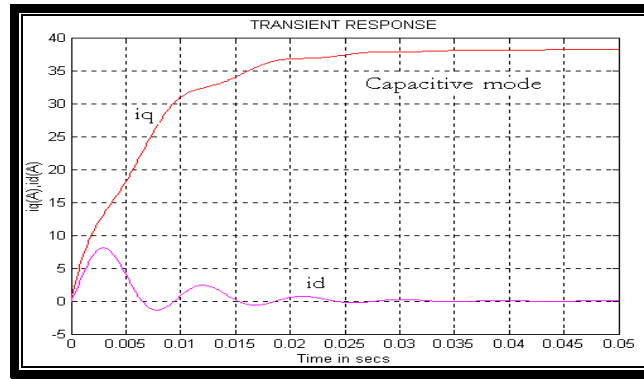

Figure 8 Transient response of i_d and i_q in capacitive mode

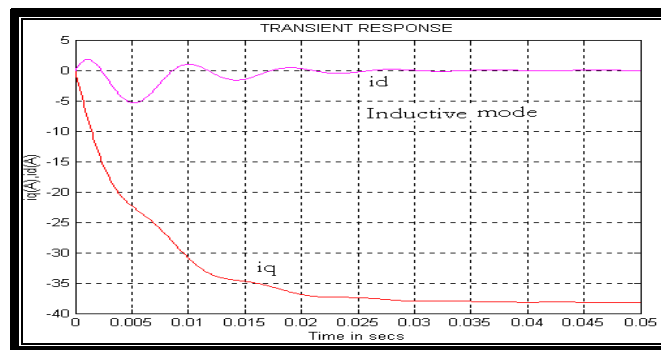

Figure 9 Transient response of i_d and i_q in inductive mode

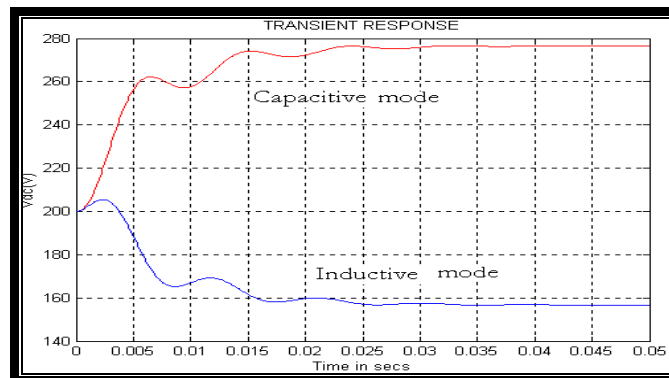

Figure 10 Transient response of v_{dc} in both modes

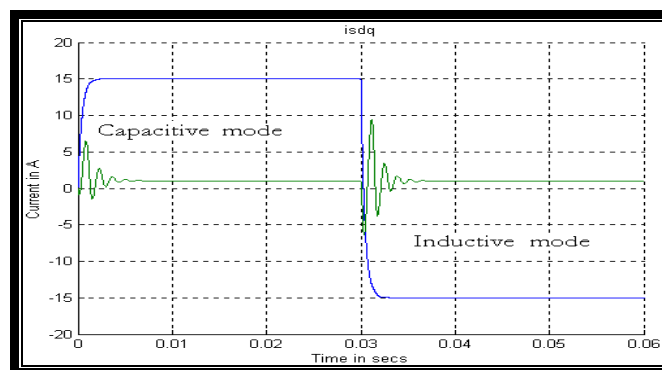

Figure 11 Current control with reference

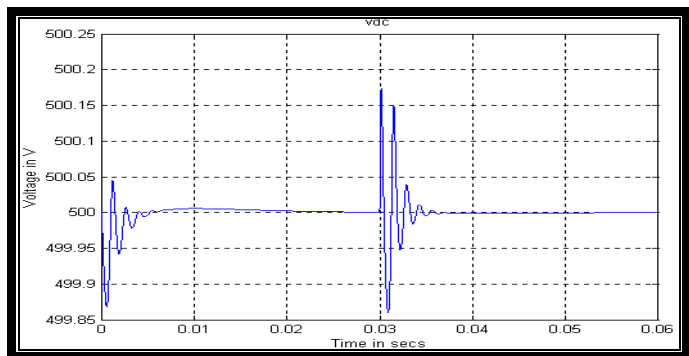

Figure 12 Voltage Control with reference

A linear load, simulated with $R-L$ parameters (given in Table-1, is connected to the Grid. The waveforms of the grid side phase-a voltage (v_{sa}) and current (i_{sa}) at point of common connection (PCC) (without the STATCOM in operation) are shown in Fig.13. It may be mentioned that here and elsewhere (unless otherwise mentioned) v_{sa} is plotted to a reduced scale of 10:1. Under steady state it is seen that the power angle is 39.64° (so that power factor is 0.77). The active power and reactive power drawn by the loads and hence supplied by the Grid Station are illustrated in Fig.14. The STATCOM will now act in closed-loop with this system along with the proposed controllers in order to improve this power factor by compensating reactive power. So the PI controllers are applied to control d and q axis current of the STATCOM and DC link voltage. These controllers work well and STATCOM functions in significant manner. The relevant output with proper dynamics is shown in Fig.15 of the system voltage and system current. It is seen that currents Grid phase voltage and current are in-phase. The Grid is now supplying only active power to the load where load is drawing reactive power from the STATCOM as shown in Fig.16.

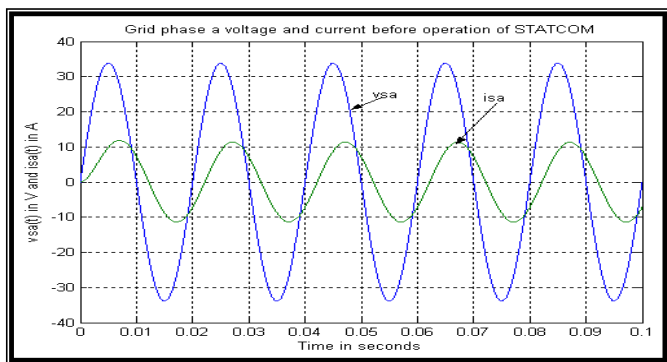

Figure 13 Grid phase-a voltage and current with $R-L$ load before operation of the STATCOM

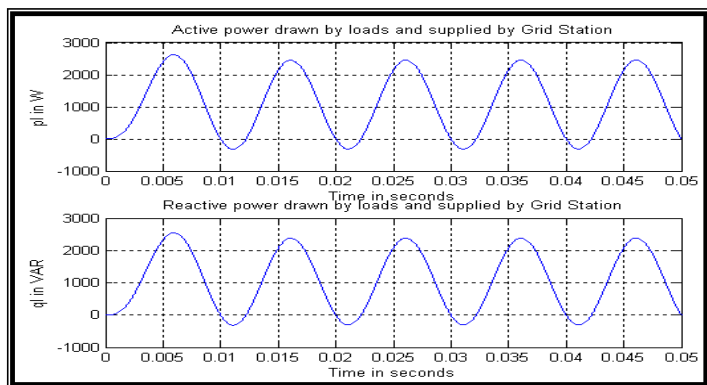

Figure 14 Grid supplied active and reactive power to $R-L$ load before operation of the STATCOM

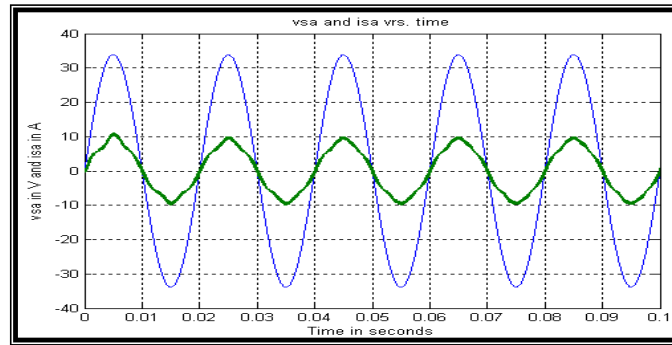

Figure 15 Grid phase-a voltage and current with $R-L$ load after operation of the STATCOM

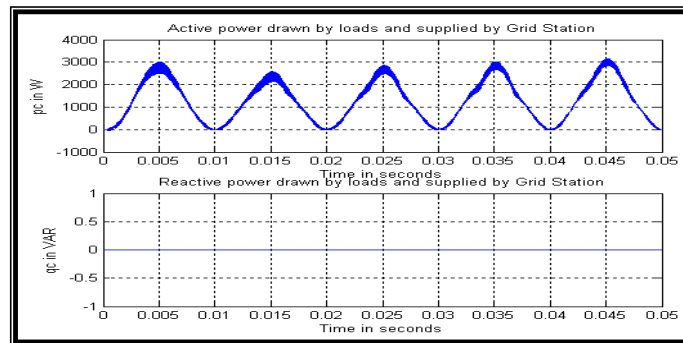

Figure 16 Grid supplied active and reactive power to $R-L$ load after operation of the STATCOM

6. CONCLUSIONS

The STATCOM is a static replacement of the age-old synchronous condenser. It is connected in shunt to the grid through an ac side reactor. Its principle of operation is similar to that of a synchronous condenser. So, it can be used as power factor compensator. Hence, it is essential to study and analyse the dynamic behaviour of the STATCOM. At the outset, the mathematical model of the STATCOM has been done. The instantaneous values of the variables (i_q, i_d, q_c and v_{dc}) are not within the limits for a practical set-up of the STATCOM. So, its closed loop control has to be investigated. Initially the mathematical model of the STATCOM is considered to be linear. The complete analysis and models of reactive current and voltage controllers of the STATCOM application are presented. The Three separate PI-controllers (for i_q, i_d and v_{dc}) have been designed on basis of frequency response method and the performances are simulated. The simulated figures are given which have been controlled the desired values. The linear $R-L$ loads are simulated and the amount of active with reactive power drawn by the loads from Grid Station is shown in Fig.13. The STATOM compensates the reactive power not to allow drawing the same from the Grid Station. These outputs have been illustrated in Figs.14 and 15. This is the uniqueness of the STATCOM application.

ACKNOWLEDGMENT

The authors would like to acknowledge the support received from the Department, Principal and BOG members of GITA, BBSR, Odisha.

REFERENCES

- [1] A.T.Johns, A.Ter-Gazarian, and F.Wame, "Flexible AC Transmission Systems (FACTS)" IEE Power and Energy Series, London, U.K.
- [2] D.M.Brod and D.W.Novotny, "Current control of VSI-PWM inverter" IEEE Trans. Industrial Appl, Vol.IA-21, pp.562-570, July/Aug.1985.
- [3] S.Busso, L.Malesani and P.Mattavelli, "Comparison of Current Control Techniques for Active Filter Application "IEEE Trans. Industrial Electronics, Vol.45, No.5, pp.722-729, October 1998.
- [4] C. Shauder and H.Mehta, "Vector Analysis and Control of Advanced Static VAR Compensators", IEE Proc, 140, No.4, pp.299-306 July 1993.
- [5] Sengupta, M., Moharana, J.K., Sengupta, A " Study on an Advanced Static VAR Compensator switched from a Space Vector PWM inverter –Analysis, simulation and comparison with the conventional sinusoidal PWM, NPEC 2003, IIT Bombay, 16-17 Oct 03 pp 72-78
- [6] L.Gyugyi, "Reactive Power Generation and Control by Thyristor Circuits", IEEE, Transactions on Industrial Application, Vol.IA-15.No.5, pp.521-532, Sept/Oct 1979.
- [7] L.Gyugyi, "Converter-Based FACTS Controllers", IEE Conference "Flexible AC Systems", pp.1/1-1/11, 23 Nov. 1998.
- [8] K.Sen and A.J.F.Keri, "Comparison of Field Results and Digital Simulation Results of Voltage Source Converter Based FACTS Controllers", IEEE, Transactions on Power Delivery, Vol.I8.No.1, pp.300-306, Jan. 2003.